

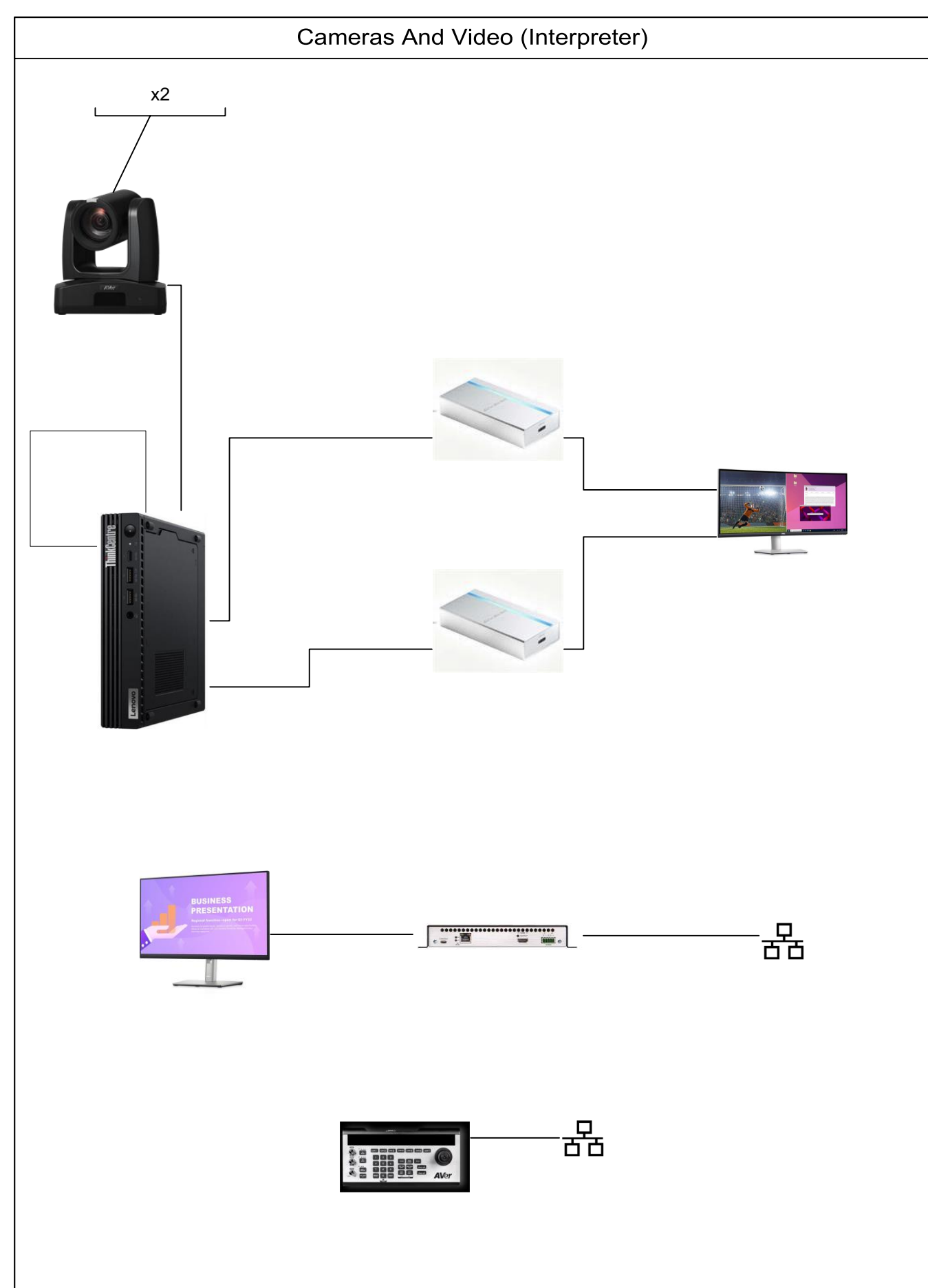

CD Consult
+55 11 29701440

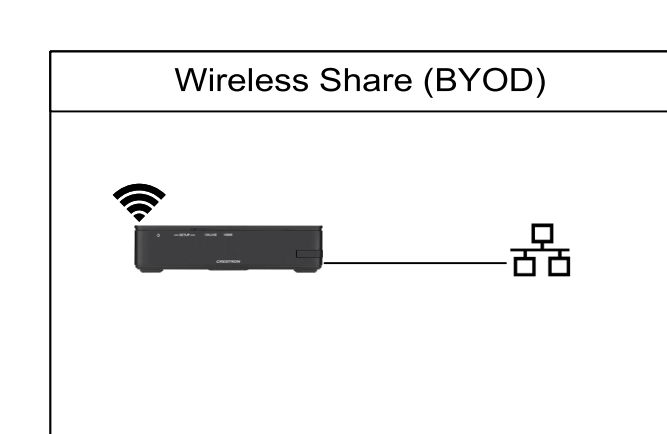
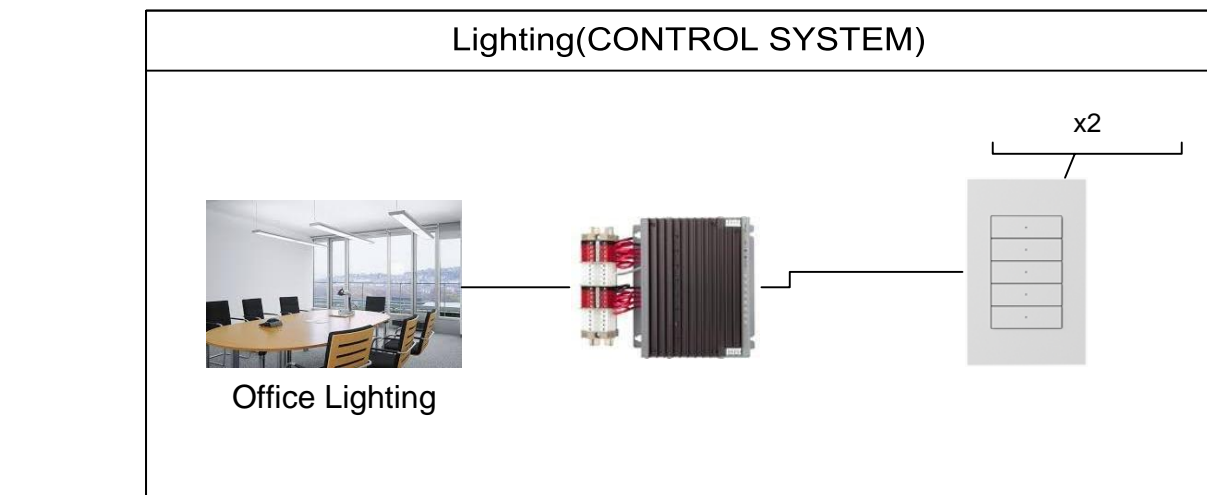
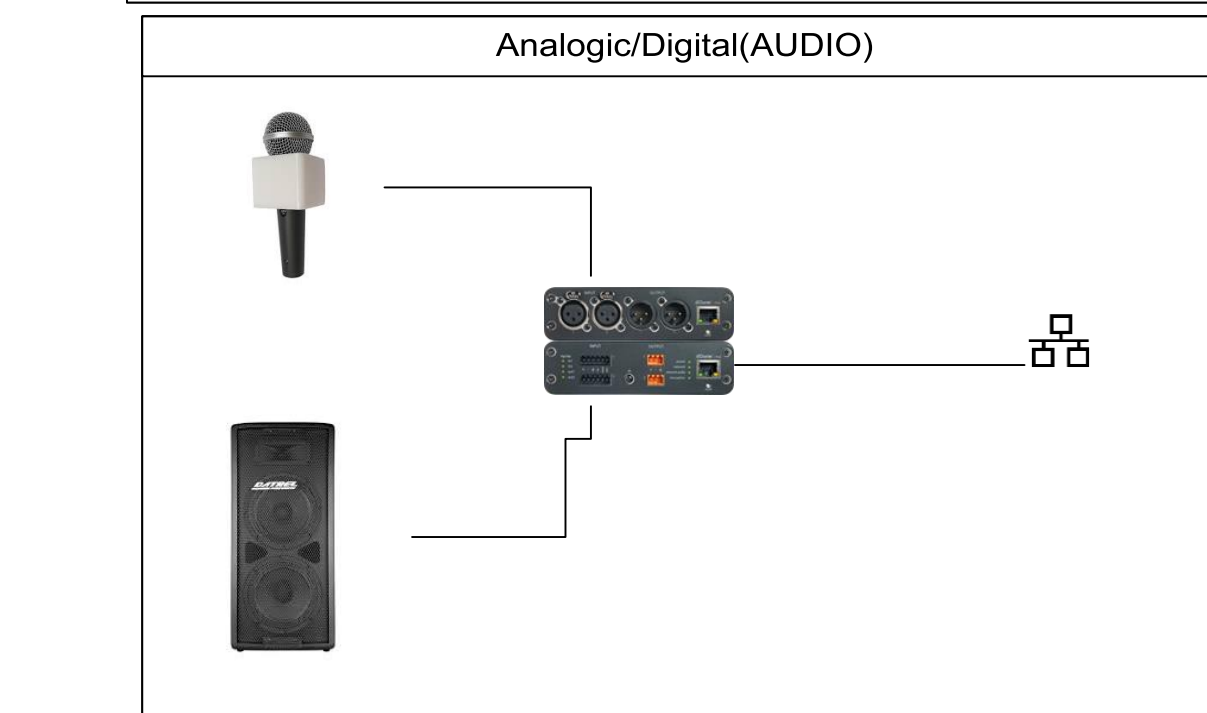
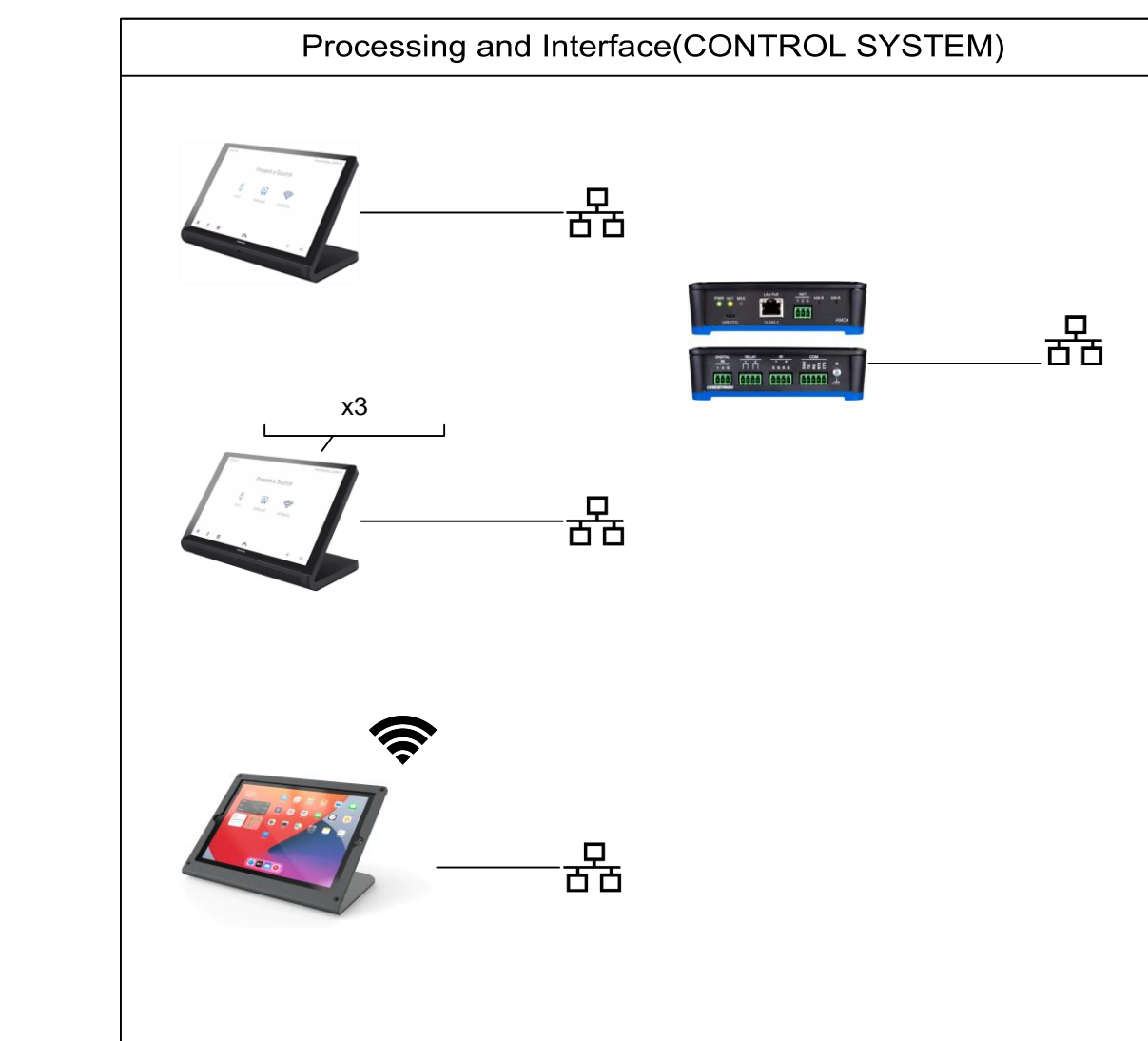
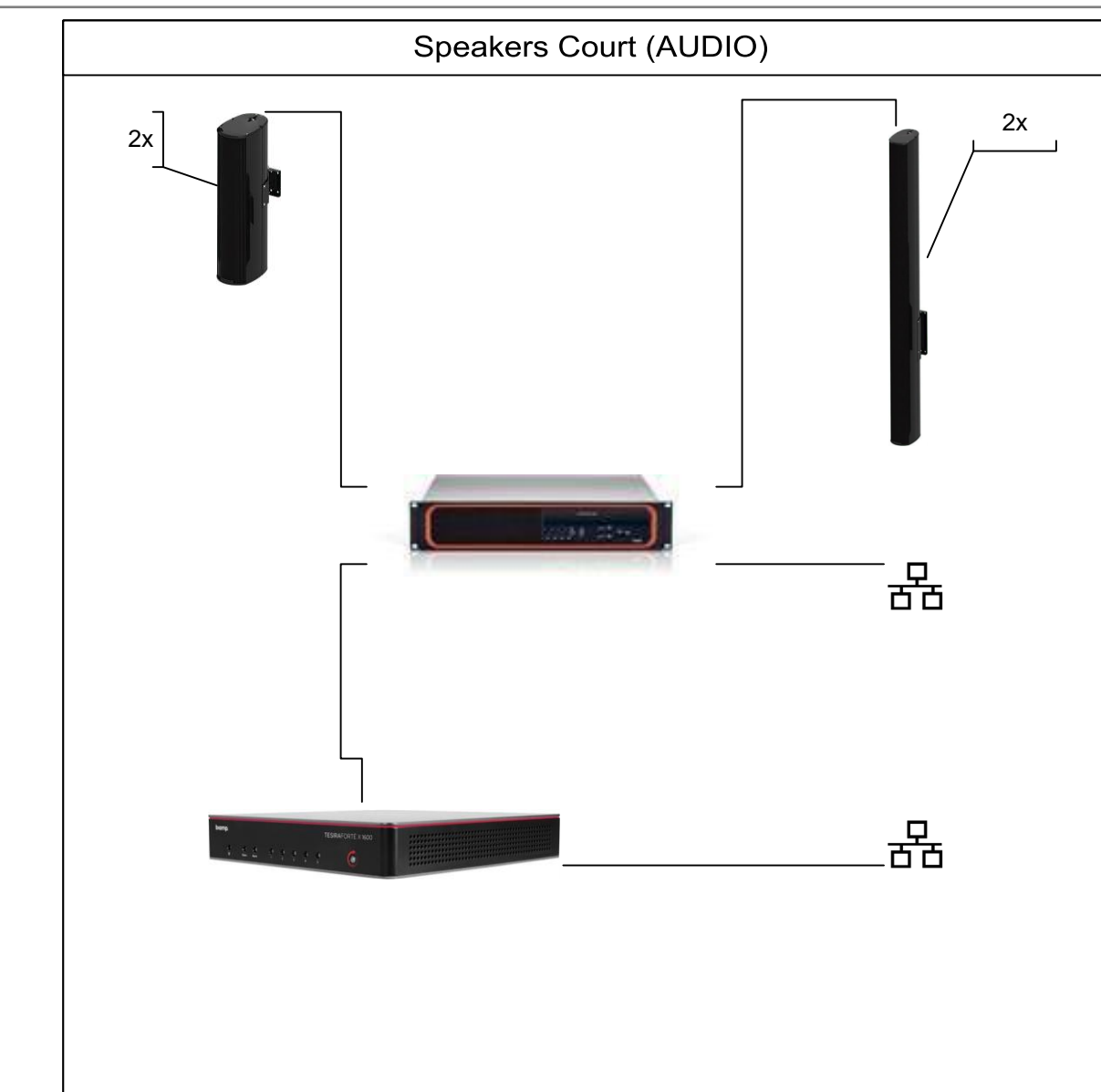
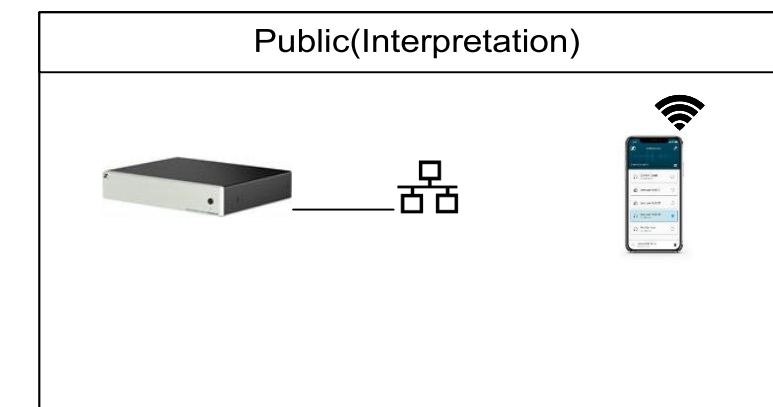
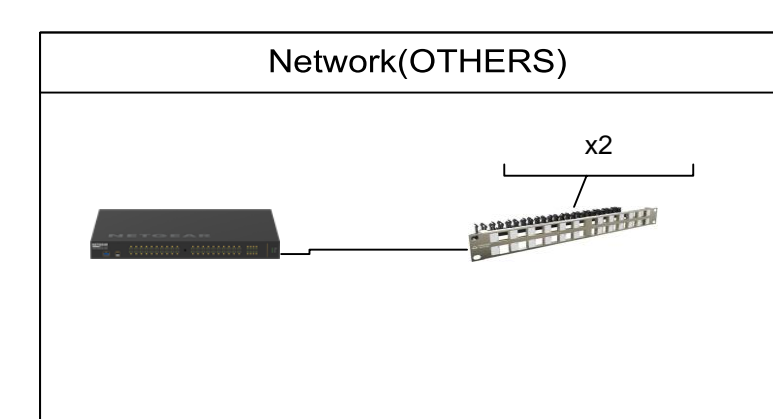
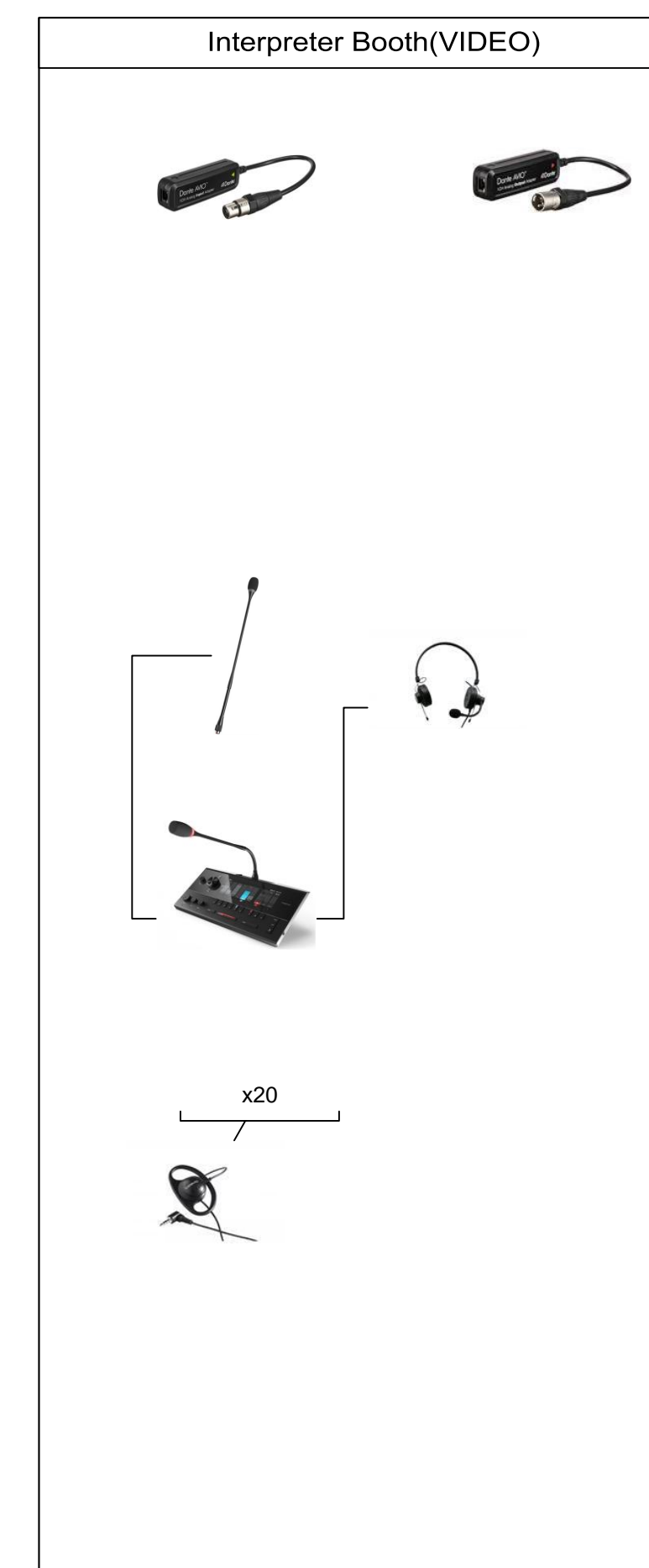
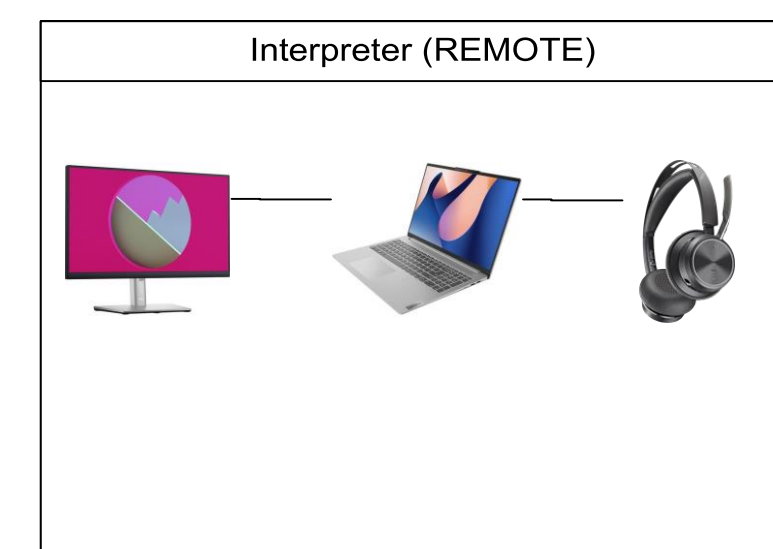
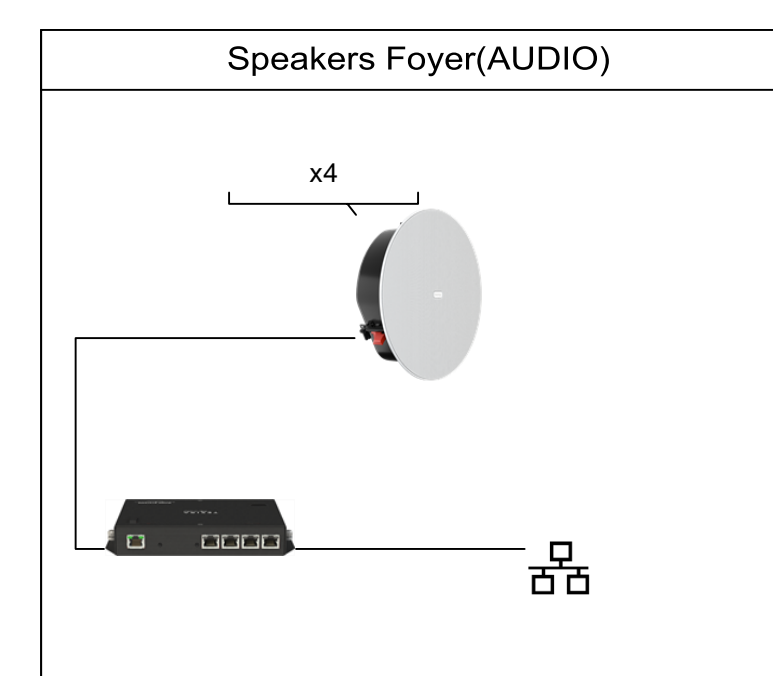
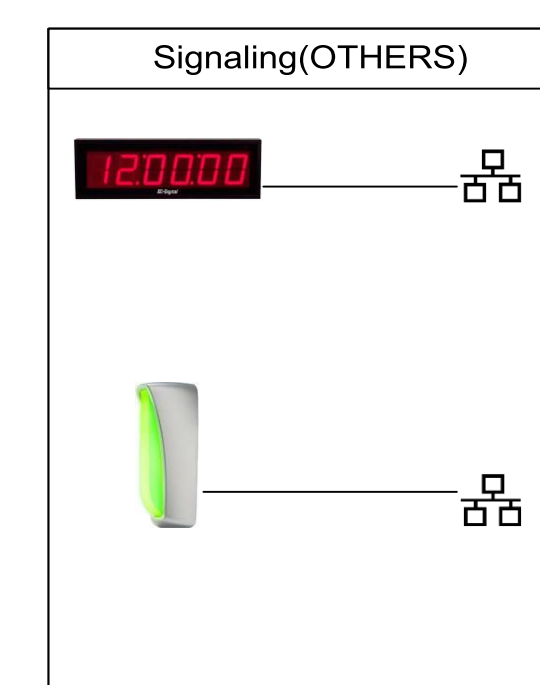
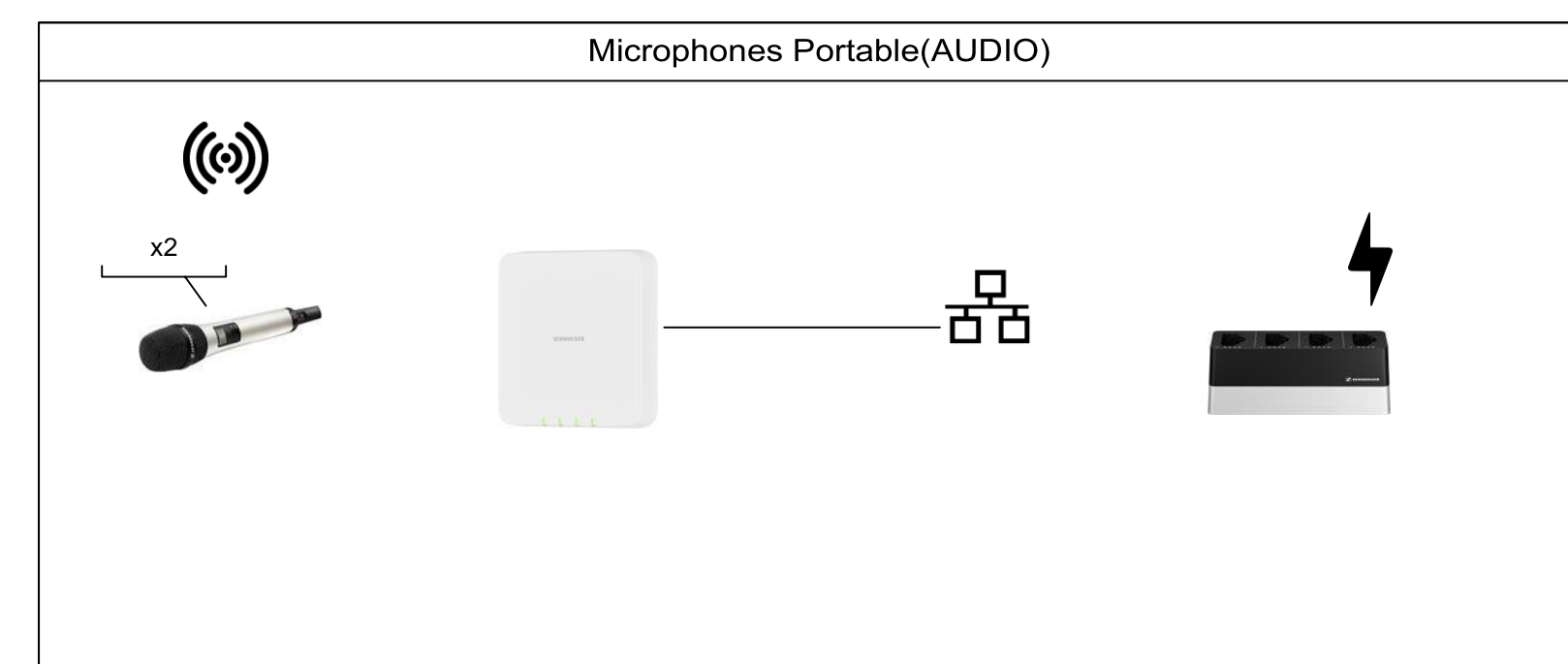
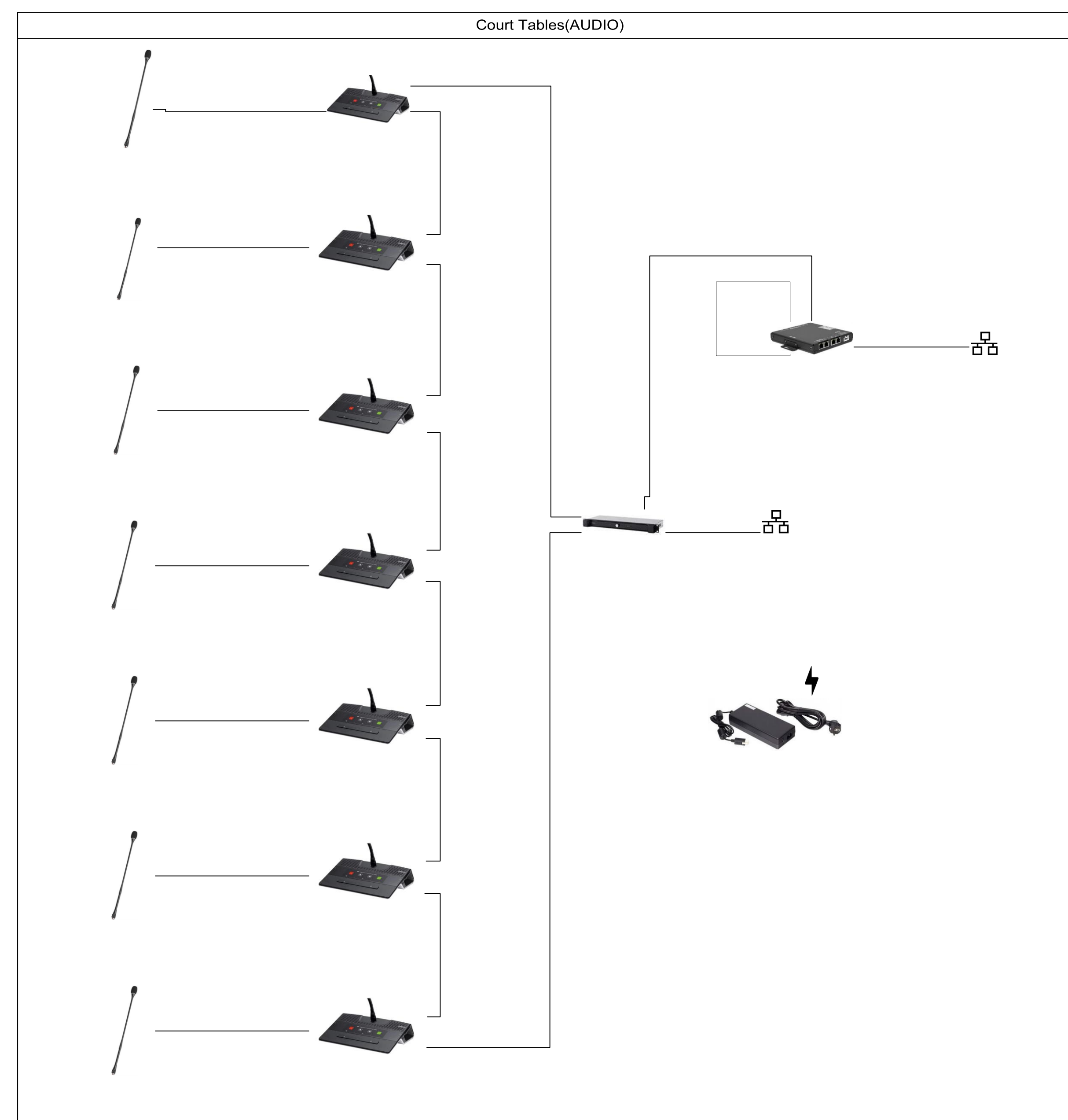
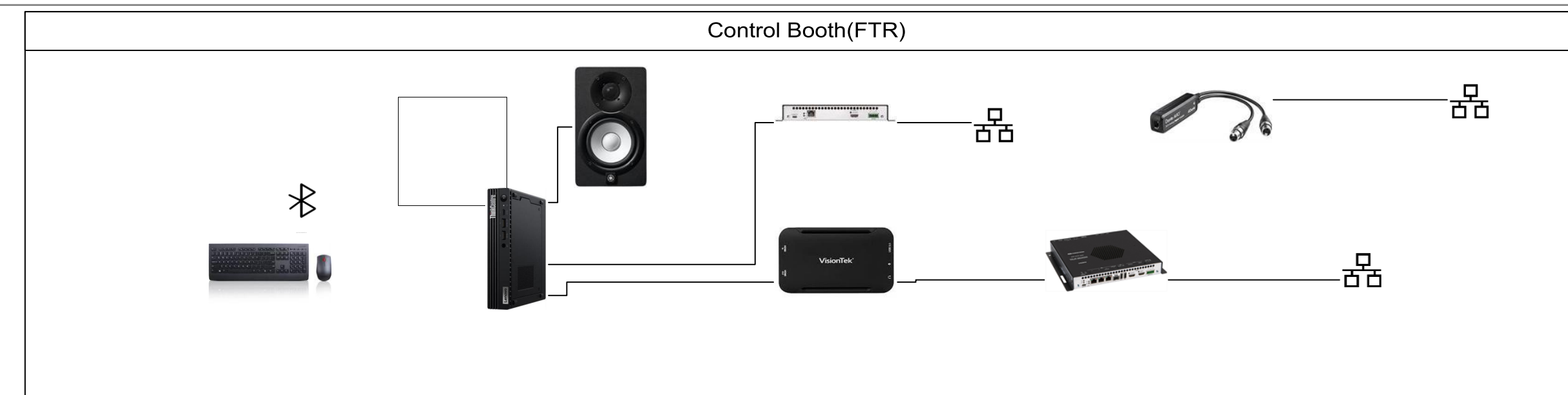
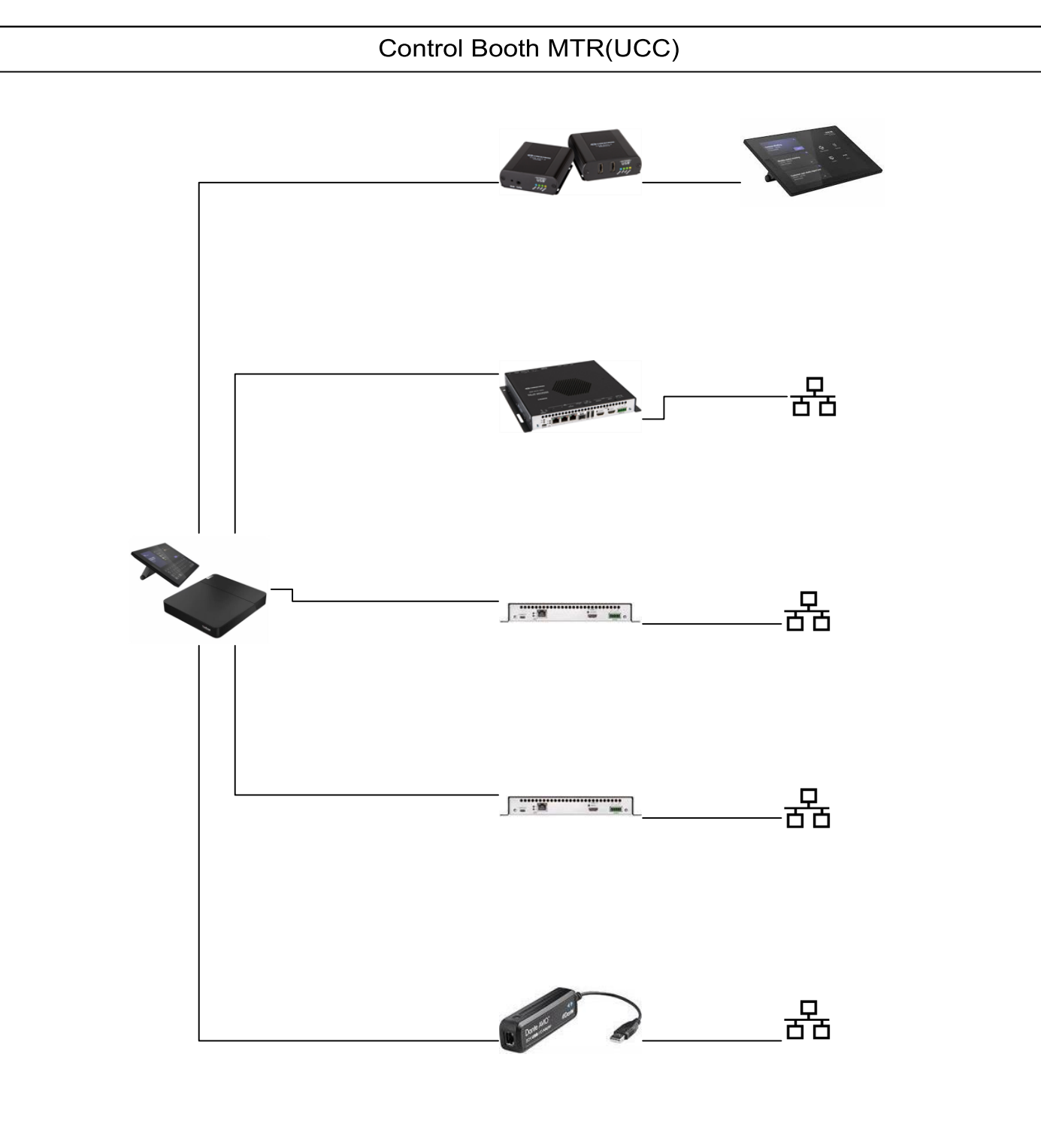
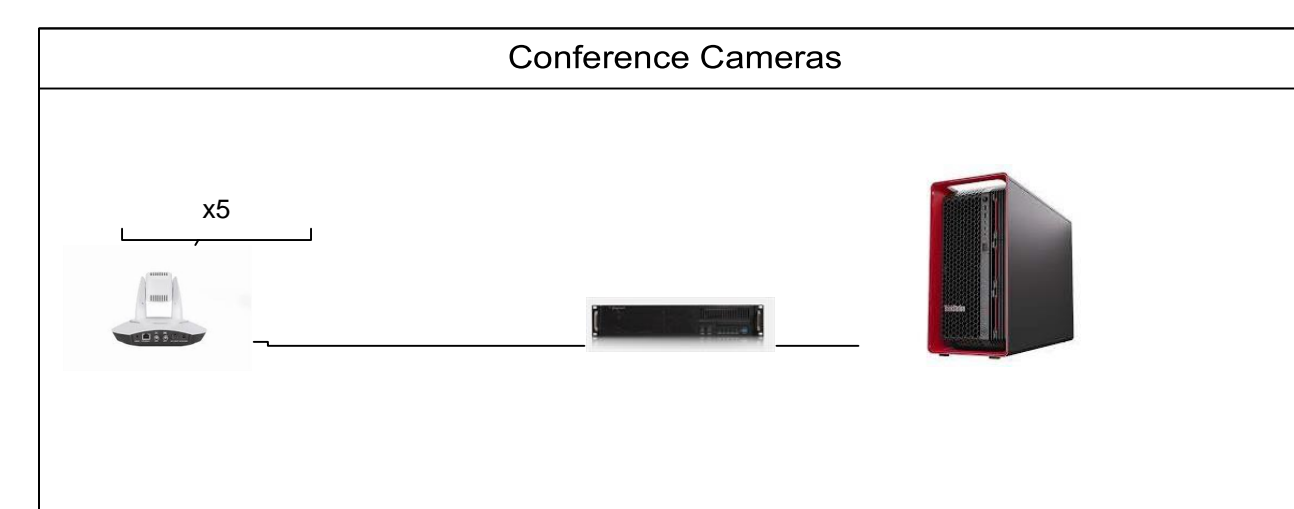
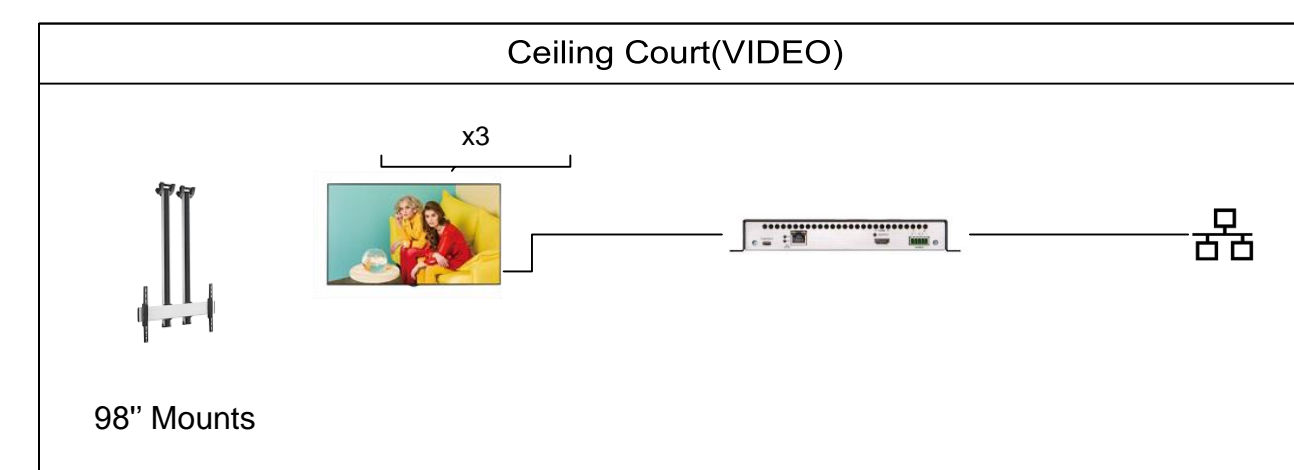
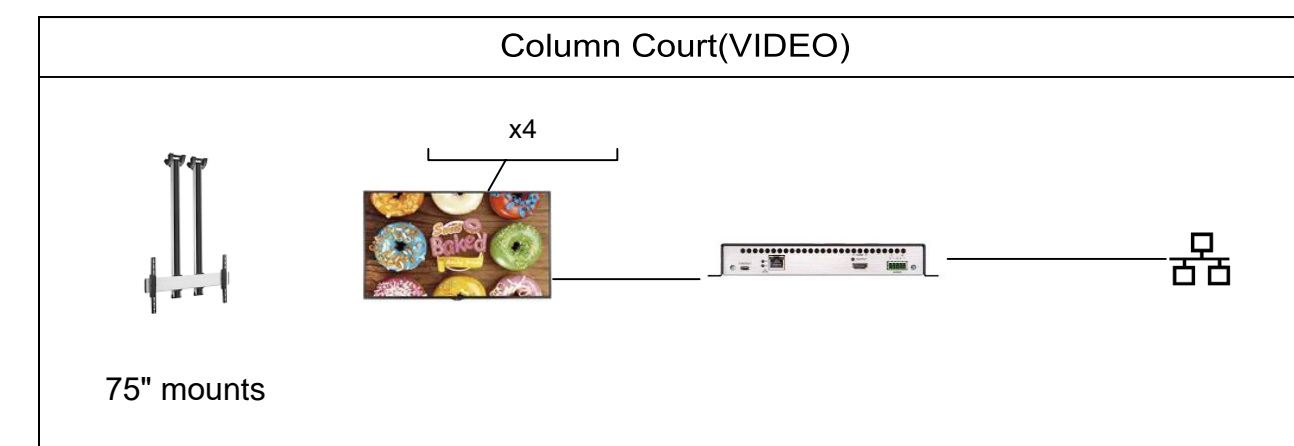
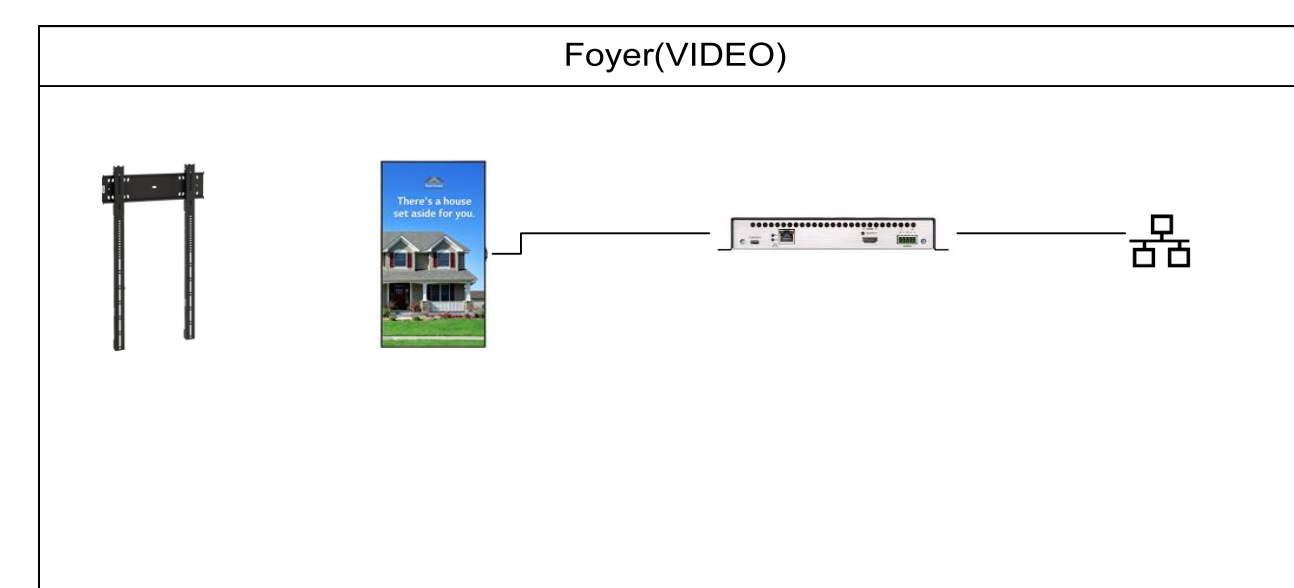
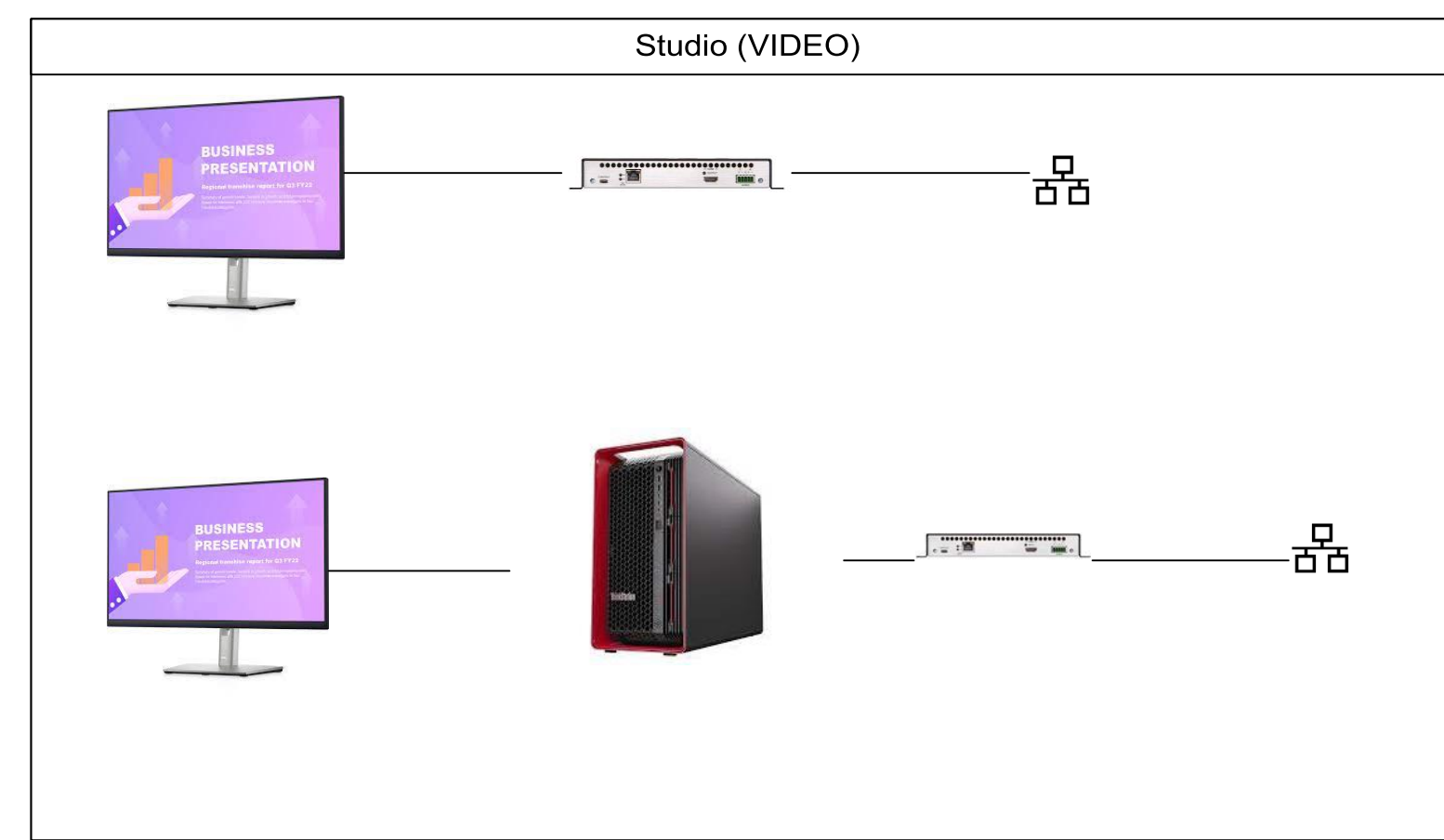
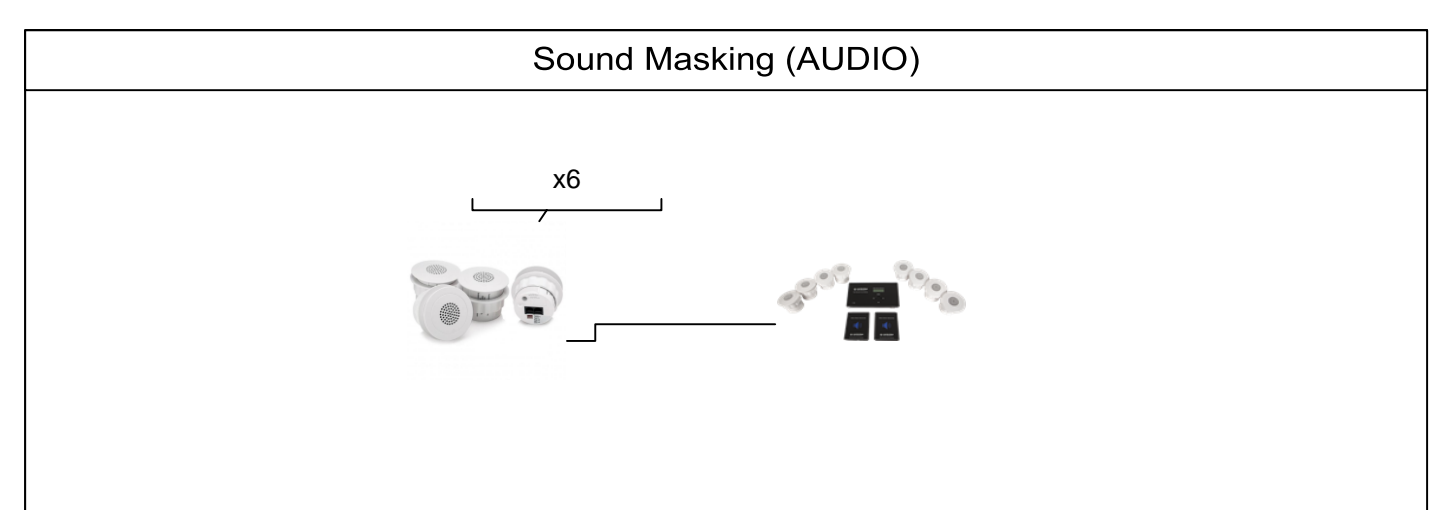
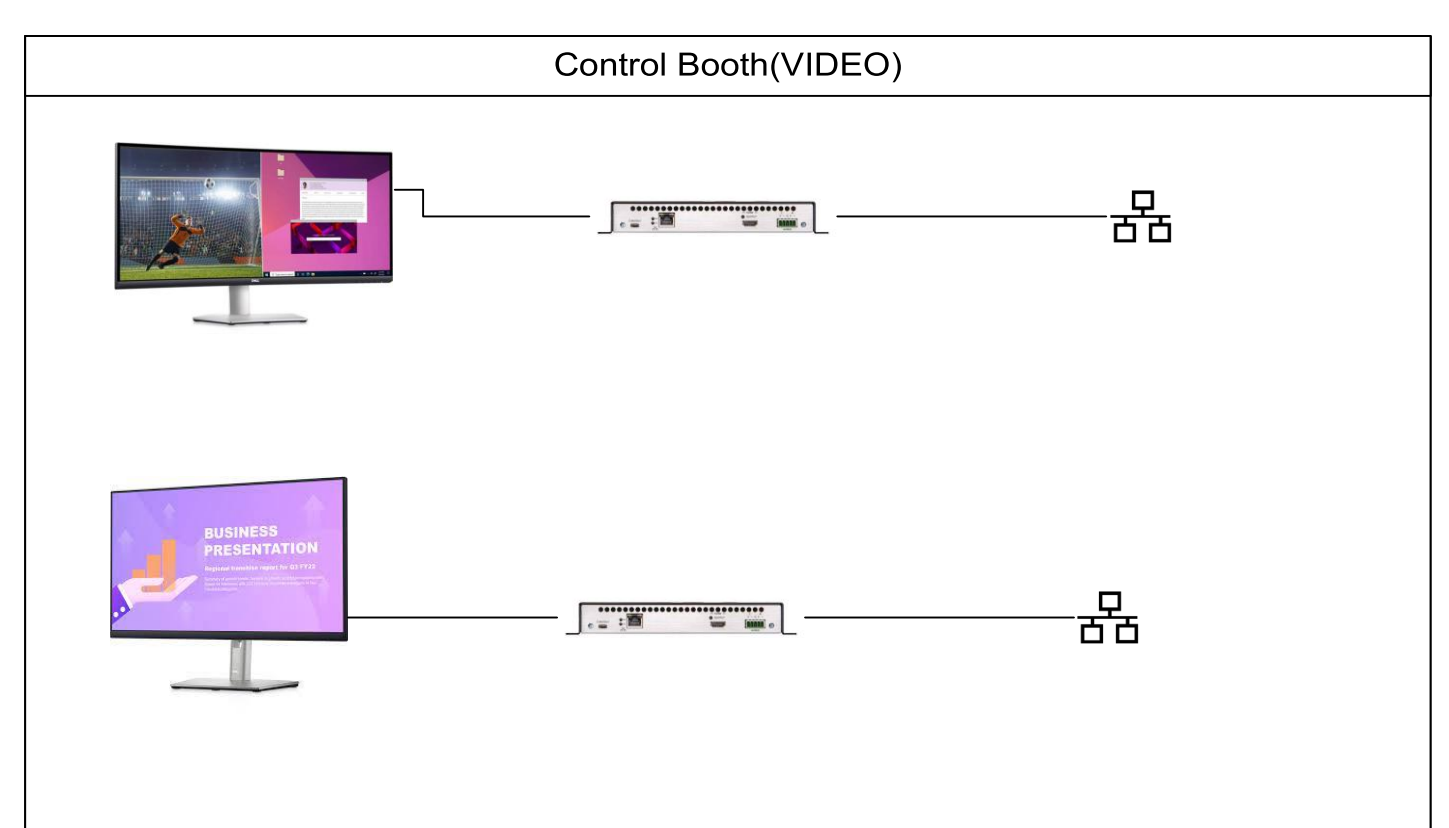
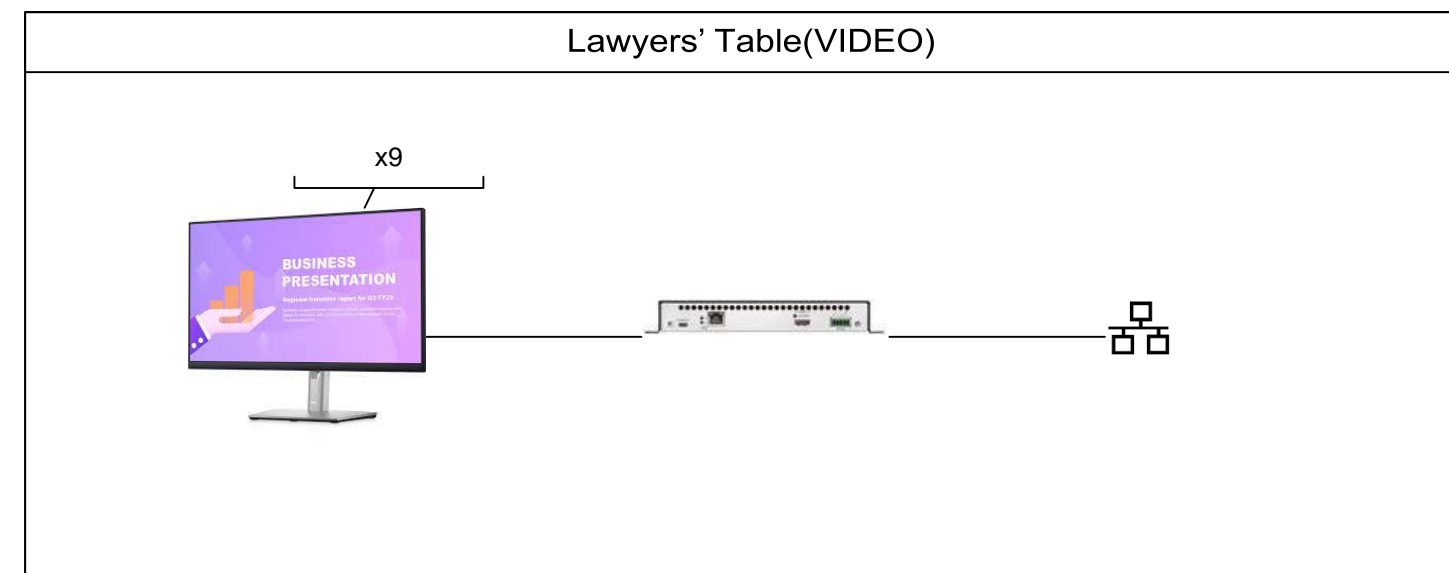
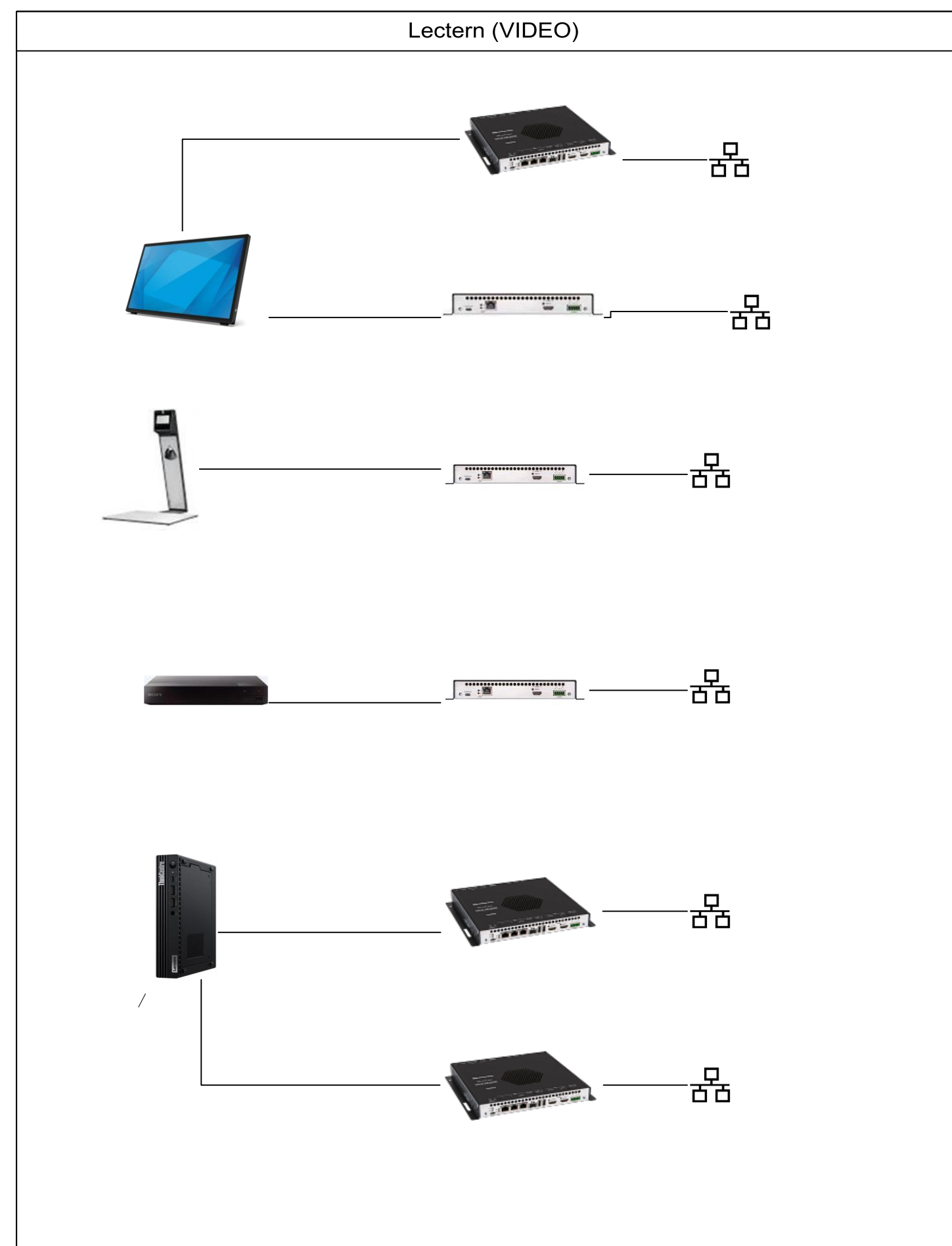
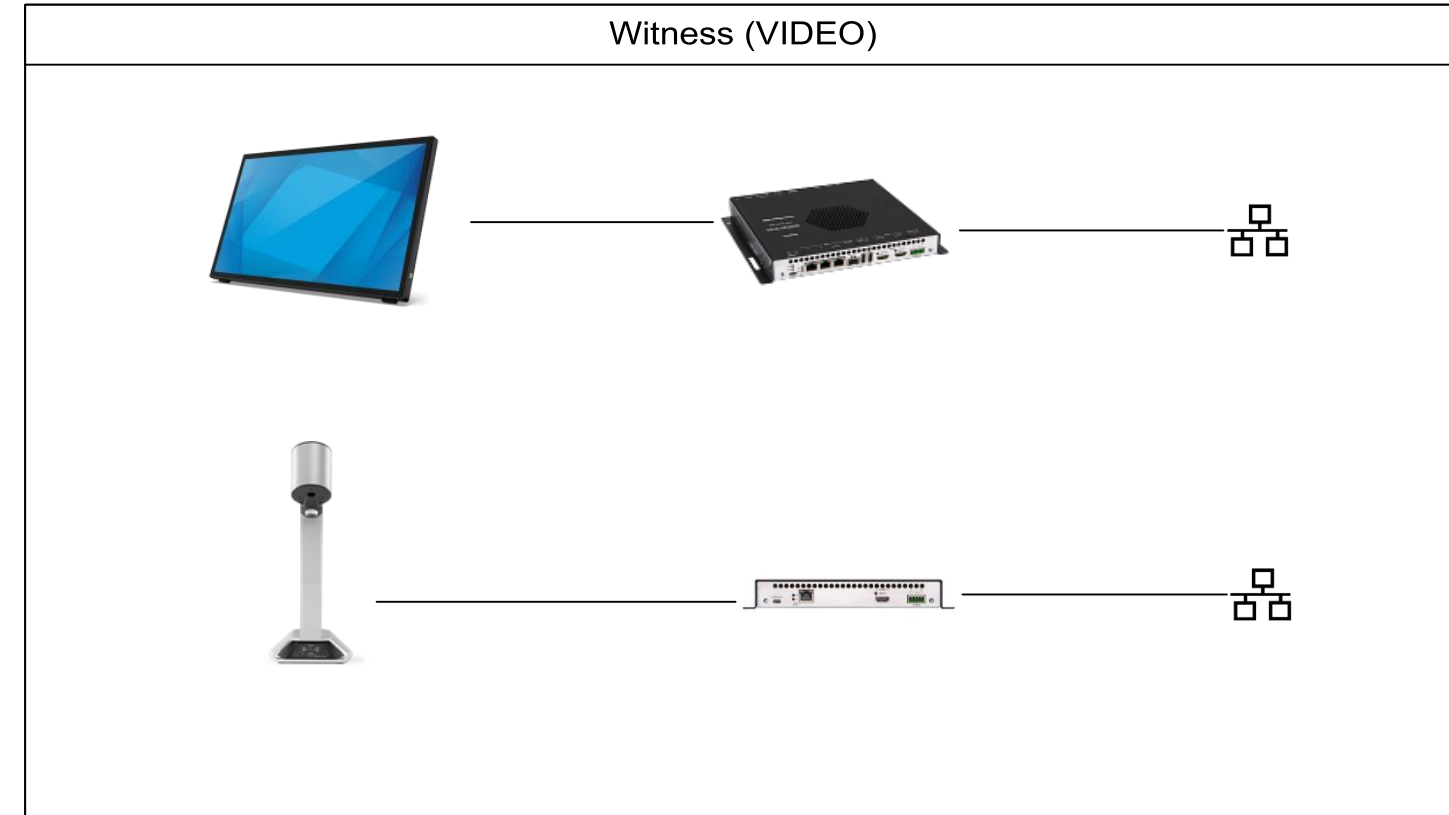
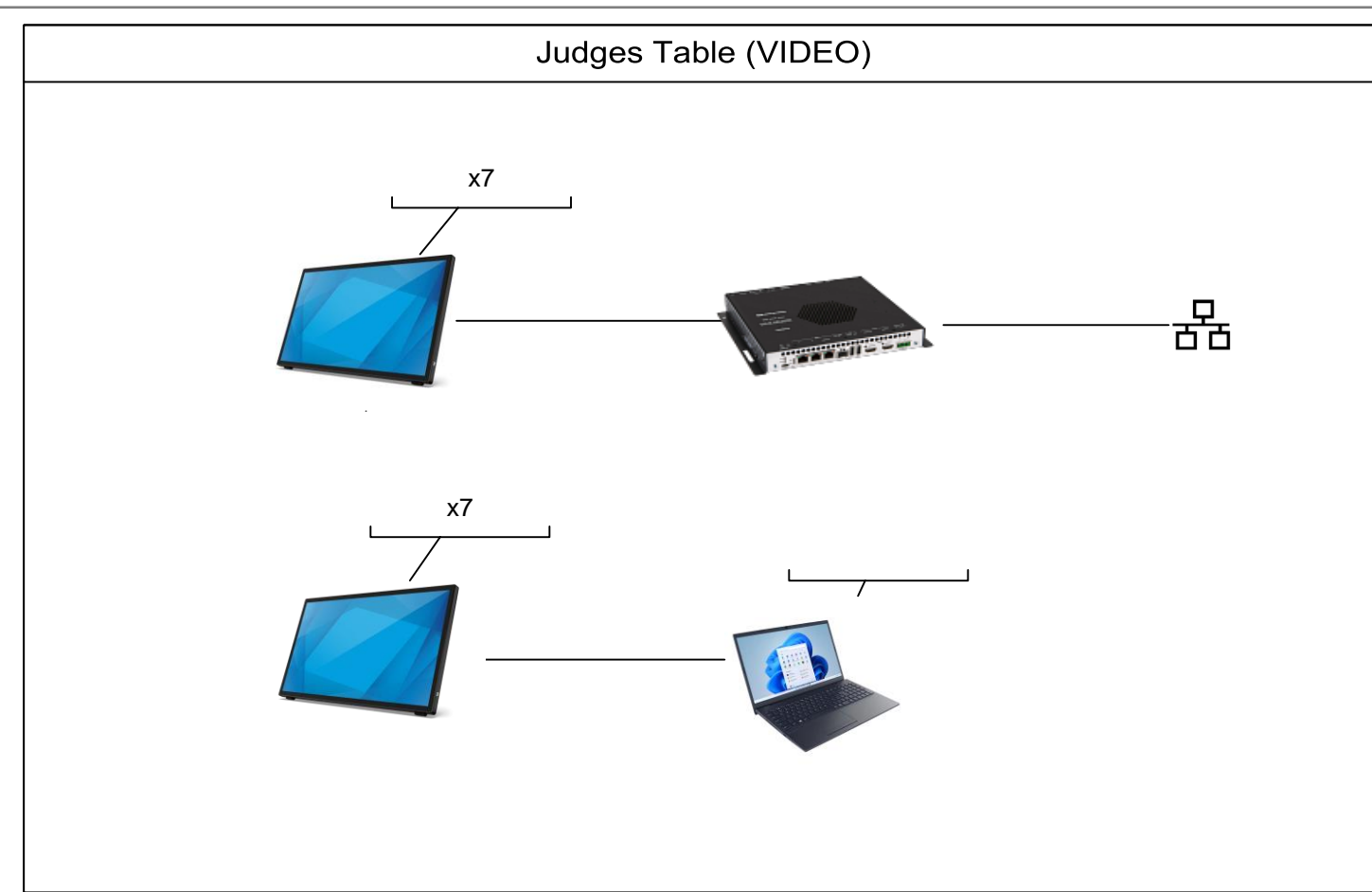

Criado 08/09/2023
Modificado 15/03/2024
Printed 15/03/2024

23-101 CCJ
John Furlonge

LD- Court 1